

Electric Mixer

Model No:R6209P

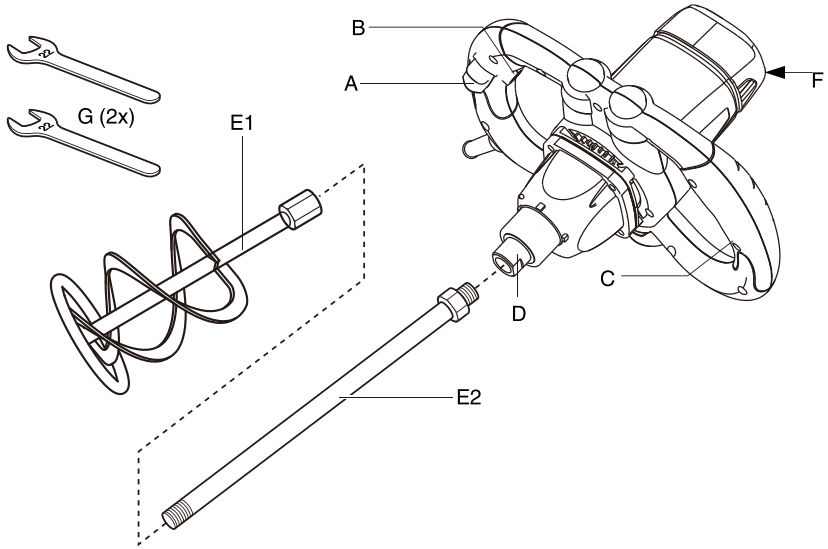

①



A Switch for on/off and speed control
C Speed selection wheel
E Mixing paddle
G Wrench (2)

B Button for switch locking
D Spindle
F Ventilation slots

②

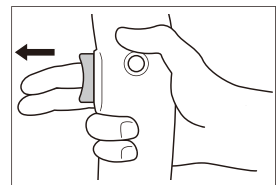
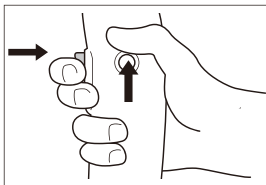

③

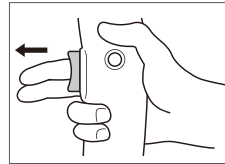
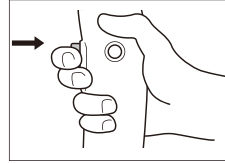
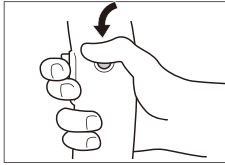
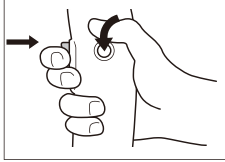
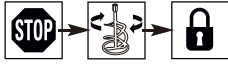

④

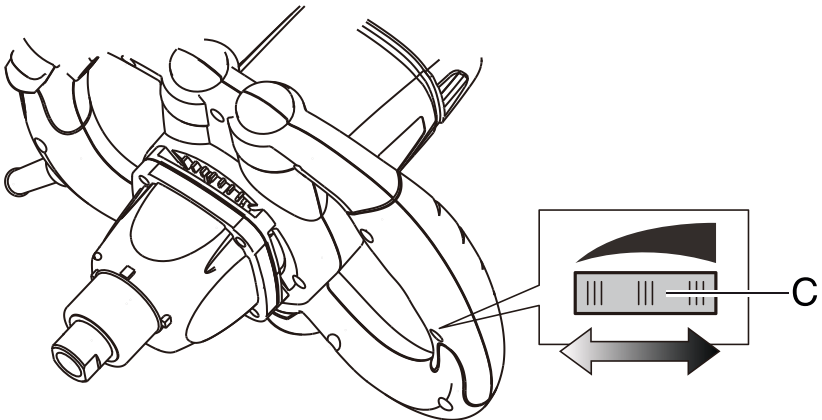

5

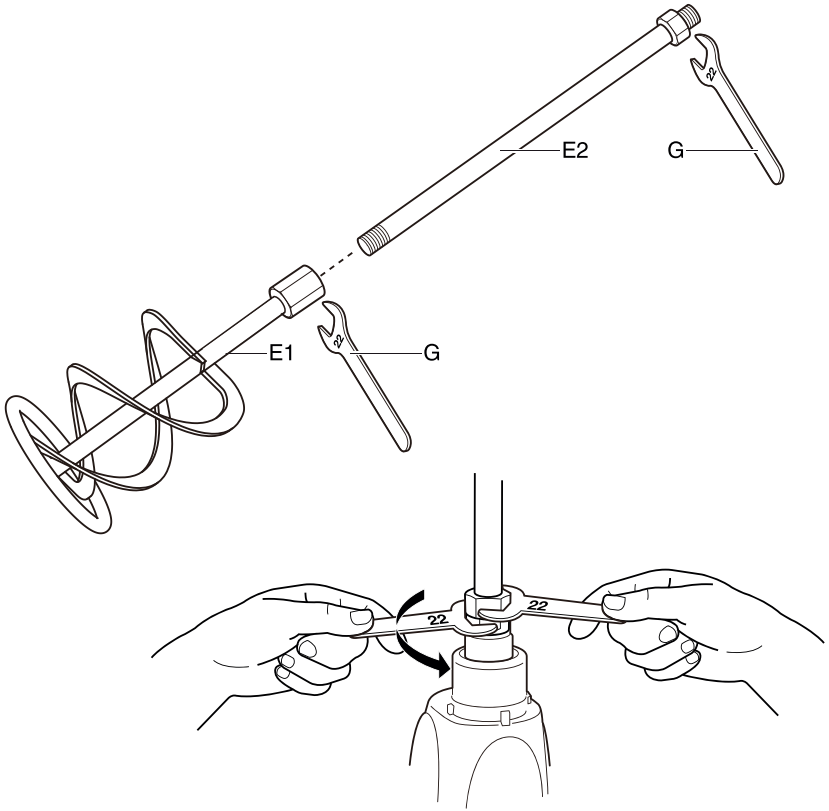

TECHNICAL SPECIFICATIONS

Model Number	R6209A	R6209B	R6209C
Voltage	110-120V~, 60Hz/220-240V~, 50Hz		
Power	1220W	1400W	1600W
No-load Speed	0-800/300-750 min ⁻¹		
Mixing paddle Dia. Ø max	120mm	140mm	160mm
Coupling thread	M14 x 2		
Protection class	II □		

SAFETY

GENERAL SAFETY INSTRUCTIONS



WARNING! Read all safety warnings and all instructions. Failure to follow the warnings and instructions may result in electric shock, fire and/or serious injury. Save all warnings and instructions for future reference. The term “power tool” in the warnings refers to your mainsoperated (corded) power tool or battery-operated (cordless) power tool.

1.WORK AREA SAFETY

- > Keep work area clean and well lit. Cluttered or dark areas invite accidents.
- > Do not operate power tools in explosive atmospheres, such as in the presence of flammable liquids, gases or dust. Power tools create sparks which may ignite the dust or fumes.
- > Keep children and bystanders away while operating a power tool. Distractions can cause you to lose control.

2.ELECTRICAL SAFETY

- > Power tool plugs must match the outlet. Never modify the plug in any way. Do not use any adapter plugs with earthed (grounded) power tools. Unmodified plugs and matching outlets will reduce risk of electric shock.
- > Avoid body contact with earthed or grounded surfaces such as pipes, radiators, ranges and refrigerators. There is an increased risk of electric shock if your body is earthed or grounded.
- > Do not expose power tools to rain or wet conditions. Water entering a power tool will increase the risk of electric shock.
- > Do not abuse the cord. Never use the cord for carrying, pulling or unplugging the power tool. Keep cord away from heat, oil, sharp edges or moving parts. Damaged or entangled cords increase the risk of electric shock.
- > When operating a power tool outdoors, use an extension cord suitable for outdoor use. Use of a cord suitable for outdoor use reduces the risk of electric shock.
- > If operating a power tool in a damp location is unavoidable, use an earth leakage circuit breaker. Use of an earth leakage circuit breaker reduces the risk of electric shock.

3.PERSONAL SAFETY

- > Stay alert, watch what you are doing and use common sense when operating a power tool. Do not use a power tool while you are tired or under the influence of drugs, alcohol or medication. A moment of inattention while operating power tools may result in serious personal injury.

- > Use personal protective equipment. Always wear eye protection. Protective equipment such as dust mask, non-skid safety shoes, hard hat, or hearing protection used for appropriate conditions will reduce personal injuries.
- > Prevent unintentional starting. Ensure the switch is in the off-position before connecting to power source and/or battery pack, picking up or carrying the tool. Carrying power tools with your finger on the switch or energising power tools that have the switch on invites accidents.
- > Remove any adjusting key or wrench before turning the power tool on. A wrench or a key left attached to a rotating part of the power tool may result in personal injury.
- > Do not overreach. Keep proper footing and balance at all times. This enables better control of the power tool in unexpected situations.
- > Dress properly. Do not wear loose clothing or jewelry. Keep your hair, clothing and gloves away from moving parts. Loose clothes, jewelry or long hair can be caught in moving parts.
- > If devices are provided for the connection of dust extraction and collection facilities, ensure these are connected and properly used. Use of dust collection can reduce dust-related hazards.

4. POWER TOOL USE AND CARE

- > Do not force the power tool. Use the correct power tool for your application. The correct power tool will do the job better and safer at the rate for which it was designed.
- > Do not use the power tool if the switch does not turn it on and off. Any power tool that cannot be controlled with the switch is dangerous and must be repaired.
- > Disconnect the plug from the power source and/or the battery pack from the power tool before making any adjustments, changing accessories, or storing power tools. Such preventive safety measures reduce the risk of starting the power tool accidentally.
- > Store idle power tools out of the reach of children and do not allow persons unfamiliar with the power tool or these instructions to operate the power tool. Power tools are dangerous in the hands of untrained users.
- > Maintain power tools. Check for misalignment or binding of moving parts, breakage of parts and any other condition that may affect the power tool's operation. If damaged, have the power tool repaired before use. Many accidents are caused by poorly maintained power tools.
- > Keep cutting tools sharp and clean. Properly maintained cutting tools with sharp cutting edges are less likely to bind and are easier to control.

- > Use the power tool, accessories and tool bits etc., in accordance with these instructions, taking into account the working conditions and the work to be performed. Use of the power tool for operations different from those intended could result in a hazardous situation.

5.SERVICE

- > Have your power tool serviced by a qualified repair person using only identical replacement parts. This will ensure that the safety of the power tool is maintained.

6.Mixer safety instructions

- > Hold the tool with both hands at the intended handles. Loss of control can cause personal injury.
- > Ensure sufficient ventilation when mixing flammable materials to avoid a hazardous atmosphere. Developing vapour may be inhaled or be ignited by the sparks the power tool produces.
- > Do not mix food. Power tools and their accessories are not designed for processing food.
- > Keep the cord away from the working area. The cord may be entangled by the mixer basket.
- > Ensure that the mixing container is placed in a firm and secure position. A container that is not properly secured may move unexpectedly.
- > Ensure that no liquid splashes against the housing of the power tool. Liquid that has penetrated the power tool can cause damage and lead to electric shock.
- > Follow the instructions and warnings for the material to be mixed. Material to be mixed may be harmful.
- > If the power tool falls into the material to be mixed, unplug the tool immediately and have the power tool checked by a qualified repair person. Reaching into the bucket with the tool still plugged in can lead to electric shock.
- > Do not reach into the mixing container with your hands or insert any other objects into it while mixing. Contact with the mixer basket may lead to serious personal injury.
- > Start up and run down the tool in the mixing container only. The mixer basket may bend or spin in an uncontrolled manner.

7.Vibration and noise reduction

To reduce the impact of noise and vibration emission, limit the time of operation, use low-vibration and low-noise operating modes as well as wear personal protective equipment.

Take the following points into account to minimise the vibration and noise exposure risks:

- > Only use the product as intended by its design and these instructions.
- > Ensure that the product is in good condition and well maintained.
- > Use correct attachments for the product and ensure they are in good condition.
- > Keep tight grip on the handles/grip surface.

- > Maintain this product in accordance with these instructions and keep it well lubricated (where appropriate).
- > Plan your work schedule to spread any high vibration tool use across a longer period of time.

8. Emergency

Familiarise yourself with the use of this product by means of this instruction manual. Memorise the safety directions and follow them to the letter. This will help to prevent risks and hazards.

- > Always be alert when using this product, so that you can recognise and handle risks early. Fast intervention can prevent serious injury and damage to property.
- > Switch off and disconnect from the power supply if there are malfunctions. Have the product checked by a qualified professional and repaired, if necessary, before you operate it again.

9. Residual risks

Even if you are operating this product in accordance with all the safety requirements, potential risks of injury and damage remain. The following dangers can arise in connection with the structure and design of this product:

- > Health defects resulting from vibration emission if the product is being used over long periods of time or not adequately managed and properly maintained.
- > Injuries and damage to property due to broken attachments or the sudden impact of hidden objects during use.
- > Danger of injury and property damage caused by flying objects.

WARNING! This product produces an electromagnetic field during operation! This field may under some circumstances interfere with active or passive medical implants! To reduce the risk of serious or fatal injury, we recommend persons with medical implants to consult their doctor and the medical implant manufacturer before operating this product!

WARNING! Some dust created by power sanding, sawing, grinding, drilling and other construction activities contains chemicals known to cause cancer, birth defects or other reproductive harm. Some examples of these chemicals are:

- Lead from lead-based paint
- Crystalline silica from bricks and cement and other masonry products
- Arsenic and chromium from chemically treated timber

Your risk from these exposures varies, depending upon how often you do this type of work. To reduce your exposure to these chemicals:

- Work in a well-ventilated area.
- Work with approved protective equipment, such as those dust masks that are specially designed to filter microscopic particles.

USE

- On/off ②

- Press lock on/off button
- Press the switch trigger to power on
- Release the switch trigger to power off

- Continuous use ③

- Press the lock on/off button to release the switch trigger
- Then press the switch trigger to power on
- Switch the lock on/off button again for continuous use

! be aware of the forces that occur as a result of jamming; hold the tool firmly with both hands and take a secure stance

- Speed control for smooth starting ④

- Operating the tool

! ensure that the tool is switched off

- mount mixing paddle E onto spindle D as illustrated ⑤
- connect plug to power source
- ensure the mixing container is securely positioned on the floor
- dip the mixing paddle into the substance to be mixed
- set wheel C to low speed
- switch on the tool
- gradually increase the mixing speed by turning wheel C to the desired maximum speed (so that the substance will not splash around and the tool will not be overloaded)

! switch the tool off only when the mixing paddle is in the mixing container

- Electronic soft-start

Ensures reaching the maximum speed smoothly without a sudden impact when tool is switched on

- Holding and guiding the tool !

! while working, always hold the tool at the grey-coloured grip area(s)

! always hold the tool firmly with both hands

MAINTENANCE / SERVICE

- Always keep tool and cord clean (especially the ventilation slots)
- always clean the mixer and functional parts after your mixing work
- clean the tool with a dry, soft cloth (do not use cleaning agents or solvents)
- clean ventilation slots F ① regularly with a brush or compressed air

! disconnect the plug before cleaning

ENVIRONMENT

- **Do not dispose of electric tools, accessories and packaging together with household waste material**(only for EU countries)
- in observance of European Directive on waste of electric and electronic equipment and its implementation in accordance with national law, electric tools that have reached the end of their life must be collected separately and returned to an environmentally compatible recycling facility

Symbols

On the product, the rating label and within these instructions you will find among others the following symbols and abbreviations. Familiarize yourself with them to reduce hazards like personal injuries and damage to property.

V~	Volt, (alternating voltage)	mm	Millimetre
Hz	Hertz	kg	Kilogram
W	Watt	dB(A)	Decibel (A-rated)
/min or min ⁻¹	Per minute	m/s ²	Metres per seconds squared
l	Liter	Nm	Newton metre



Lock / to tighten or secure.



Unlock / to loosen.



Note / Remark.



Caution / Warning.



Read the instruction manual.



Wear hearing protection.



Wear eye protection.



Wear a dust mask.



Wear protective gloves.



Wear protective, slip-resistant footwear.



Switch the product off and disconnect it from the power supply before assembly, cleaning, adjustments, maintenance, storage and transportation.



This product is of protection class II. That means it is equipped with enhanced or double insulation.



The product complies with the applicable European directives and an evaluation method of conformity for these directives was done.



WEEE symbol. Waste electrical products should not be disposed of with household waste. Please recycle where facilities exist. Check with your Local Authority or local store for recycling advice.

