

Impact drill

Model No: R8606

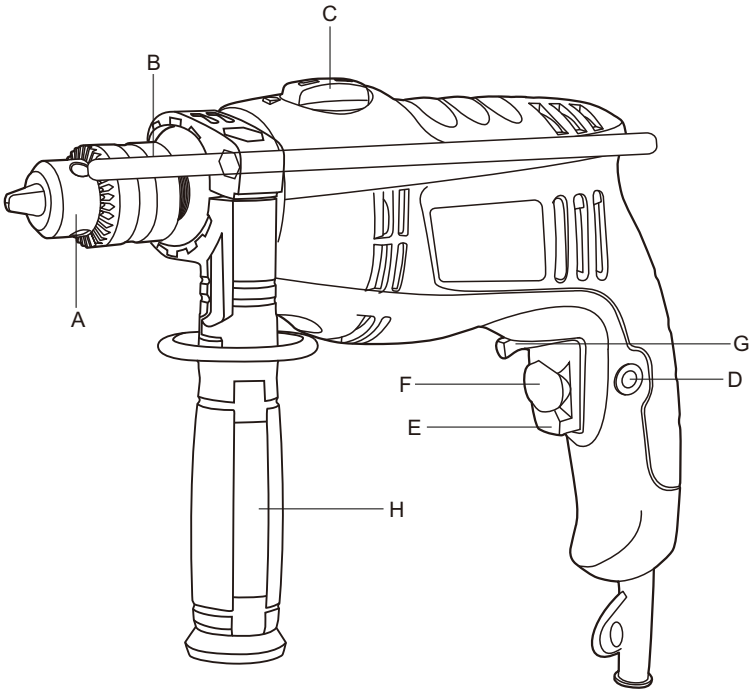

①



A. Drill chuck

B. Depth gauge

C. Switch for drilling / hammer drilling

D. Locking button

E. On/off switch

F. Speed selection wheel

G. Rotation direction switch

H. Side handle

②

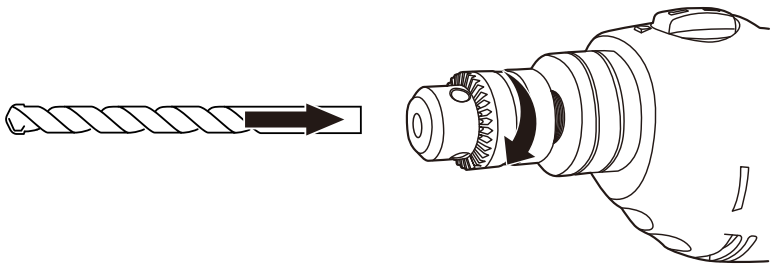

④

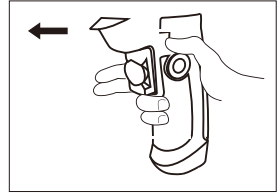
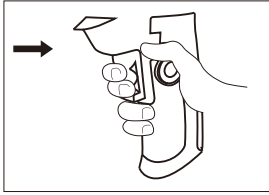
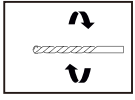

⑤

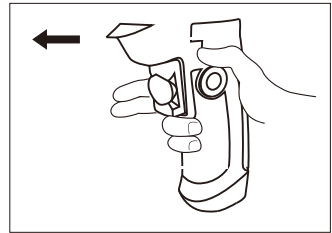
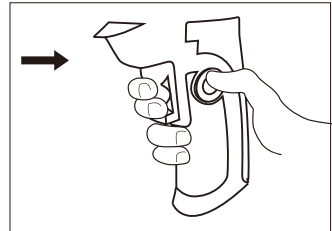
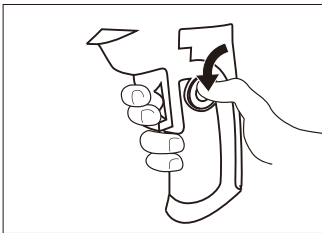
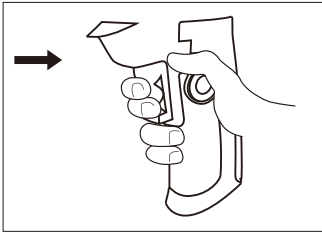
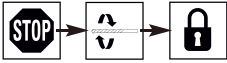

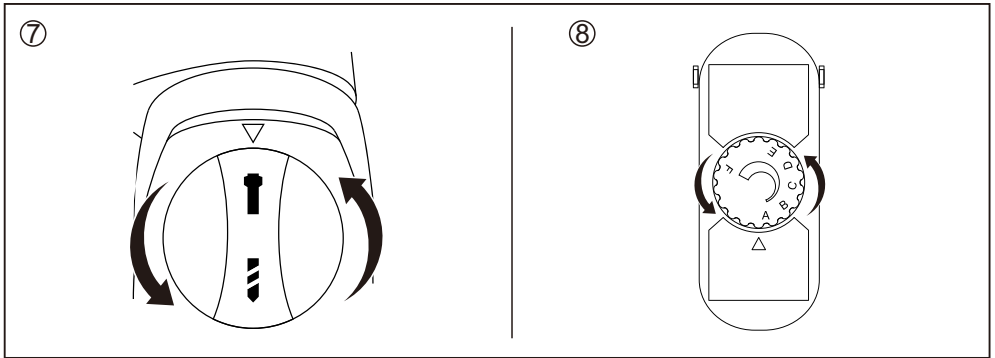
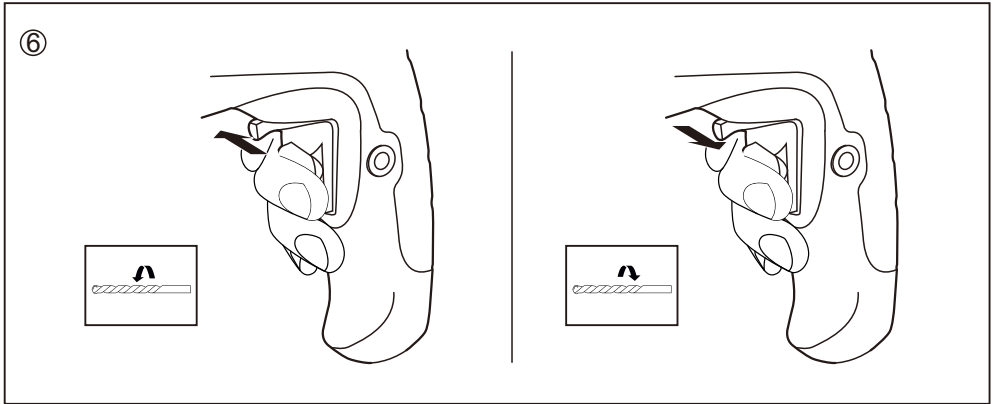

TECHNICAL SPECIFICATIONS

Model No.		R8606
Power		550W
Voltage		230-240V~, 110-120V~, 50/60Hz
No Load Speed		0-2900/min
Blows Per Minute		0-48000BPM
Chuck Capacity		1.3-13mm
Drill Capacity	Metal	13mm
	Masonry	13mm
	Wood	25mm
Weight		1.9kg
Protection class		II □

SAFETY

GENERAL SAFETY INSTRUCTIONS



WARNING! Read all safety warnings and all instructions. Failure to follow the warnings and instructions may result in electric shock, fire and/or serious injury. Save all warnings and instructions for future reference. The term “power tool” in the warnings refers to your mainsoperated (corded) power tool or battery-operated (cordless) power tool.

1.WORK AREA SAFETY

- > Keep work area clean and well lit. Cluttered or dark areas invite accidents.
- > Do not operate power tools in explosive atmospheres, such as in the presence of flammable liquids, gases or dust. Power tools create sparks which may ignite the dust or fumes.
- > Keep children and bystanders away while operating a power tool. Distractions can cause you to lose control.

2.ELECTRICAL SAFETY

- > Power tool plugs must match the outlet. Never modify the plug in any way. Do not use any adapter plugs with earthed (grounded) power tools. Unmodified plugs and matching outlets will reduce risk of electric shock.
- > Avoid body contact with earthed or grounded surfaces such as pipes, radiators, ranges and refrigerators. There is an increased risk of electric shock if your body is earthed or grounded.
- > Do not expose power tools to rain or wet conditions. Water entering a power tool will increase the risk of electric shock.
- > Do not abuse the cord. Never use the cord for carrying, pulling or unplugging the power tool. Keep cord away from heat, oil, sharp edges or moving parts. Damaged or entangled cords increase the risk of electric shock.
- > When operating a power tool outdoors, use an extension cord suitable for outdoor use. Use of a cord suitable for outdoor use reduces the risk of electric shock.
- > If operating a power tool in a damp location is unavoidable, use an earth leakage circuit breaker. Use of an earth leakage circuit breaker reduces the risk of electric shock.

3.PERSONAL SAFETY

- > Stay alert, watch what you are doing and use common sense when operating a power tool. Do not use a power tool while you are tired or under the influence of drugs, alcohol or medication. A moment of inattention while operating power tools may result in serious personal injury.

- > Use personal protective equipment. Always wear eye protection. Protective equipment such as dust mask, non-skid safety shoes, hard hat, or hearing protection used for appropriate conditions will reduce personal injuries.
- > Prevent unintentional starting. Ensure the switch is in the off-position before connecting to power source and/or battery pack, picking up or carrying the tool. Carrying power tools with your finger on the switch or energising power tools that have the switch on invites accidents.
- > Remove any adjusting key or wrench before turning the power tool on. A wrench or a key left attached to a rotating part of the power tool may result in personal injury.
- > Do not overreach. Keep proper footing and balance at all times. This enables better control of the power tool in unexpected situations.
- > Dress properly. Do not wear loose clothing or jewelry. Keep your hair, clothing and gloves away from moving parts. Loose clothes, jewelry or long hair can be caught in moving parts.
- > If devices are provided for the connection of dust extraction and collection facilities, ensure these are connected and properly used. Use of dust collection can reduce dust-related hazards.

4. POWER TOOL USE AND CARE

- > Do not force the power tool. Use the correct power tool for your application. The correct power tool will do the job better and safer at the rate for which it was designed.
- > Do not use the power tool if the switch does not turn it on and off. Any power tool that cannot be controlled with the switch is dangerous and must be repaired.
- > Disconnect the plug from the power source and/or the battery pack from the power tool before making any adjustments, changing accessories, or storing power tools. Such preventive safety measures reduce the risk of starting the power tool accidentally.
- > Store idle power tools out of the reach of children and do not allow persons unfamiliar with the power tool or these instructions to operate the power tool. Power tools are dangerous in the hands of untrained users.
- > Maintain power tools. Check for misalignment or binding of moving parts, breakage of parts and any other condition that may affect the power tool's operation. If damaged, have the power tool repaired before use. Many accidents are caused by poorly maintained power tools.
- > Keep cutting tools sharp and clean. Properly maintained cutting tools with sharp cutting edges are less likely to bind and are easier to control.

> Use the power tool, accessories and tool bits etc., in accordance with these instructions, taking into account the working conditions and the work to be performed. Use of the power tool for operations different from those intended could result in a hazardous situation.

5.SERVICE

> Have your power tool serviced by a qualified repair person using only identical replacement parts. This will ensure that the safety of the power tool is maintained.

SAFETY INSTRUCTIONS FOR DRILLS

- Wear ear defenders when hammer drilling. The effects of noise can result in a loss of hearing.
- Use the additional handles supplied with the device. Losing control may cause injuries.
- Hold the device by the insulated surfaces when carrying out work during which it is possible that the tool or screw may come across hidden power cables or its own cable. Contact with a cable that carries power will subject the metal parts of the device to current and will lead to electrical shock.

USE

- Attaching the side handle(H)
Push the side handle (H) over the drill chuck and screw into place.
- Inserting a bits
Place the bits as far as it will go into the drill chuck (A). Then tighten the rear sleeve of the tool mount by hand. Tighten the rear sleeve of the tool mount using the drill chuck key.





WARNING! Make sure that when installing the tool that it fits securely in the clamping chuck and is not at an angle.

- On/off
- Switch locking for continuous use
- Changing the rotation direction
To drill and screw screws into place, press the rotation direction switch (G) to the left (rotation in clockwise direction).
To remove screws, press the rotation direction switch to the right (rotation in an anti-clockwise direction).



Only use the rotation direction switch when the device is at a standstill.

- Selecting the operating mode
Position [] for hammer drilling in cement or stone.
Position [] for drilling without the hammer function into wood, metal, ceramics and plastics and for the screw-driver function.



Only change operating mode when the device is switched off.

- Variable speed dial



The motor can overheat when running at low speeds under continuous heavy load. Cool off the motor by running at high speed without a load.

- Wood Drilling

- For maximum performance, use wood bits for wood drilling.
- Selector to drill mode.
- Secure the workpiece to prevent it from turning when drilling.
- Begin drilling at a very low speed to prevent the bit from slipping off the starting point. Increase the speed as the drill bit bites into the material.
- When drilling through the holes, place a block of wood behind the workpiece to prevent ragged or splintered edges on the back side of the hole.

- Metal Drilling

- For maximum performance, use high speed steel bits for metal or steel drilling.
- Selector to drill mode.
- Use a center punch to mark the hole location on the workpiece.
- Begin drilling at a very low speed to prevent the bit from slipping off the starting point.
- Maintain speed and pressure which allows cutting without overheating the bit.

Applying too much pressure will:

Overheat the drill

Wear the bearings

Bend or burn bits

Produce off-center or irregular shaped holes

- When drilling large holes in metal, it is recommended to drill with a small bit at first, then finish with a larger bit. Also, lubricate the bit with oil to improve drilling action and increase bit life.

- Masonry Drilling

- For maximum performance use masonry bits when drilling holes in brick, tile, concrete, etc.
- Selector to hammer mode.
- Apply light pressure and medium speed for best results in brick.
- Apply additional pressure and high speed for hard materials such as concrete.
- When drilling in tile, practice on a scrap piece to determine the best speed and pressure.

MAINTENANCE / SERVICE

- Always keep tool and cord clean (especially the ventilation slots)
 - always clean the mixer and functional parts after your mixing work
 - clean the tool with a dry, soft cloth (do not use cleaning agents or solvents)
 - clean ventilation slots regularly with a brush or compressed air
- ! disconnect the plug before cleaning**

ENVIRONMENT

- **Do not dispose of electric tools, accessories and packaging together with household waste material**(only for EU countries)
 - in observance of European Directive on waste of electric and electronic equipment and its implementation in accordance with national law, electric tools that have reached the end of their life must be collected separately and returned to an environmentally compatible recycling facility

Symbols

On the product, the rating label and within these instructions you will find among others the following symbols and abbreviations. Familiarize yourself with them to reduce hazards like personal injuries and damage to property.

V~	Volt, (alternating voltage)	mm	Millimetre
Hz	Hertz	kg	Kilogram
W	Watt	dB(A)	Decibel (A-rated)
/min or min ⁻¹	Per minute	m/s ²	Metres per seconds squared
l	Liter	Nm	Newton metre



Lock / to tighten or secure.



Unlock / to loosen.



Note / Remark.



Caution / Warning.



Read the instruction manual.



Wear hearing protection.



Wear eye protection.



Wear a dust mask.



Wear protective gloves.



Wear protective, slip-resistant footwear.



Switch the product off and disconnect it from the power supply before assembly, cleaning, adjustments, maintenance, storage and transportation.



This product is of protection class II. That means it is equipped with enhanced or double insulation.



The product complies with the applicable European directives and an evaluation method of conformity for these directives was done.



WEEE symbol. Waste electrical products should not be disposed of with household waste. Please recycle where facilities exist. Check with your Local Authority or local store for recycling advice.

