

DRYWALL SANDER

Model No:R7246A-SG

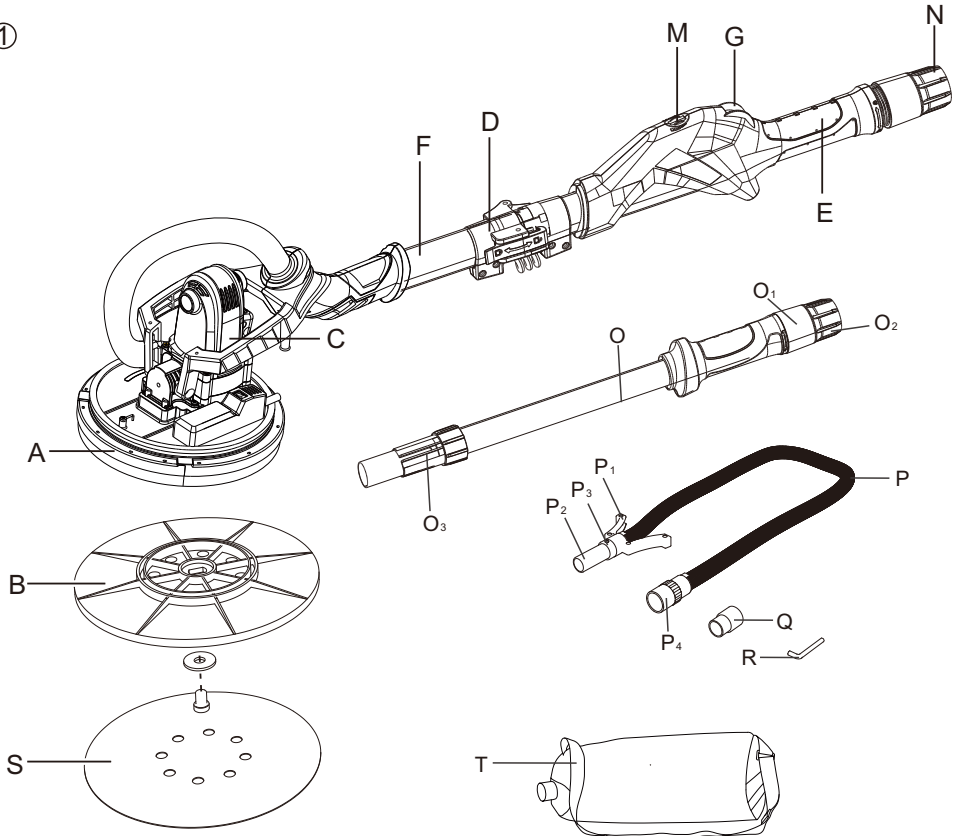

①



- A** Round sanding head
- B** Round sanding pad (hook & loop system)
- C** Motor Housing(self-suction)
- D** Folding lock
- E** Main handle
- F** Shaft
- G** On/ Off switch
- M** Electronic speed control wheel
- N** Dust extration outlet(with locking sleeve)

- O** Extension shaft
- 1** Rear handle
- 2** Dust extraction outlet (with adjusting sleeve)
- 3** Sleeve
- P** Vacuum hose
- 1** Stand
- 2** Connector(pre-assembled)(38mm)
- 3** Suction power adjustment ring
- 4** Vacuum adaptor(pre-assembled)(47mm)
- Q** Vacuum adaptor(pre-assembled)(35mm)
- R** Hex wrench S5
- S** Round sanding disc
- T** Dust bag

②

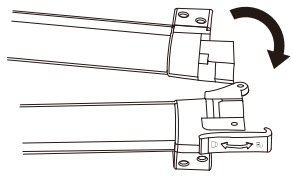

2a

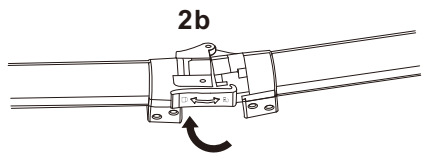

2b

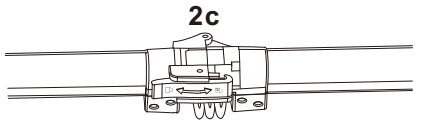

2c

③

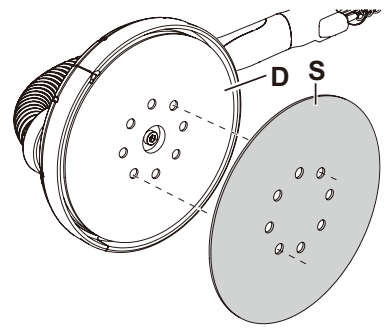
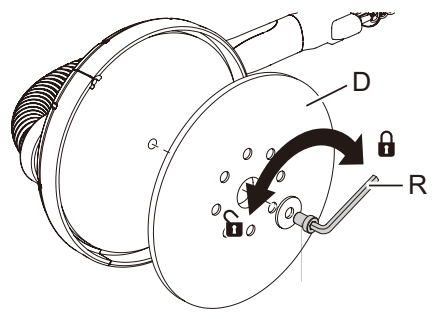

④

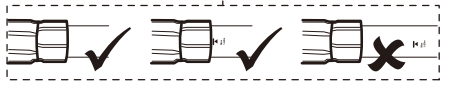
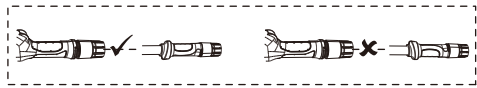
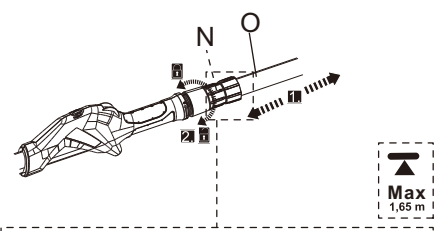
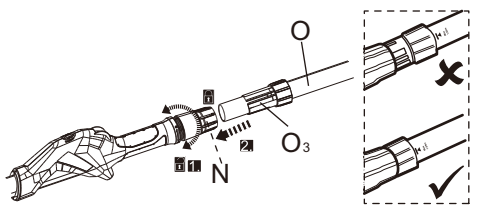

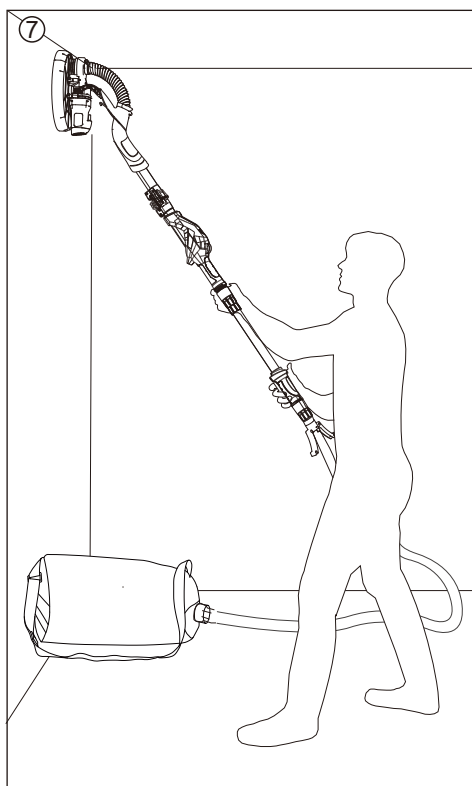
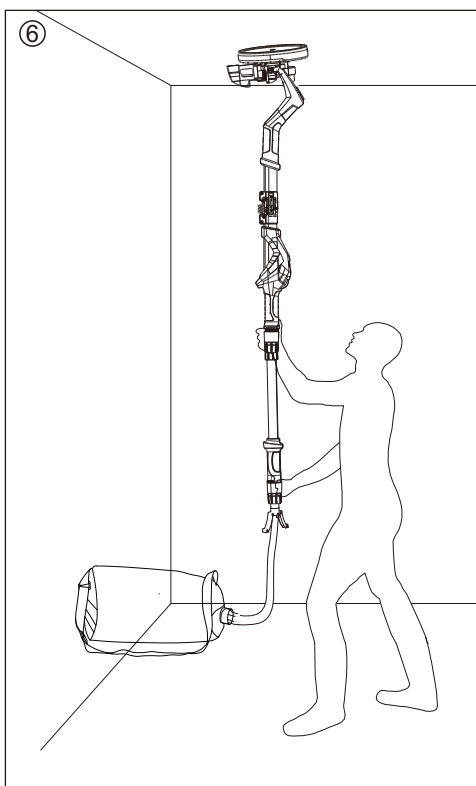
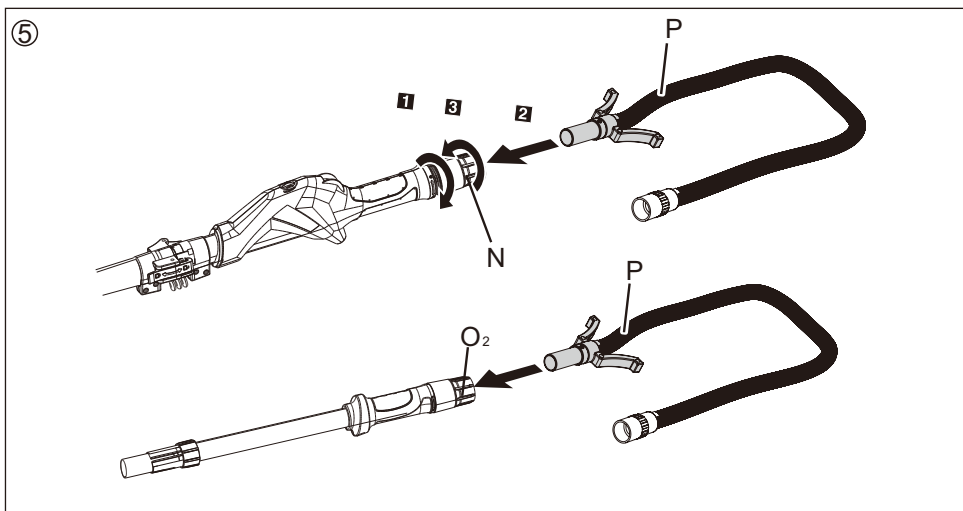

⑧

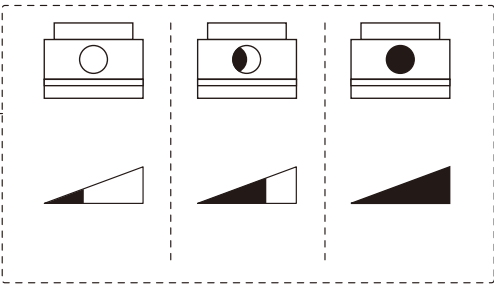
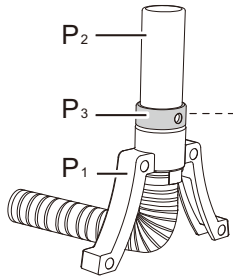

⑨

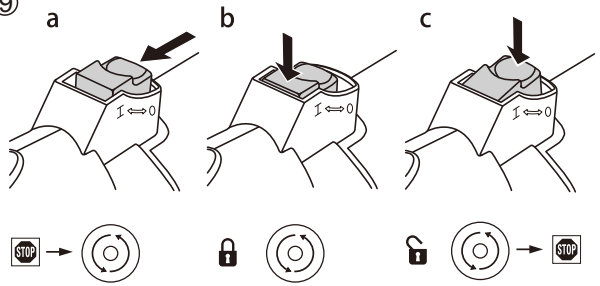

⑩

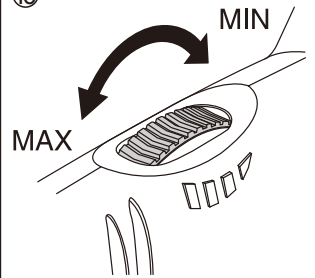

⑪

Sanding ceiling-how to fix the head.

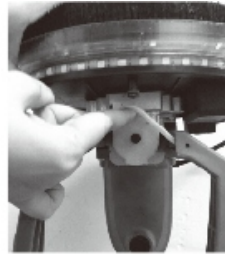

TECHNICAL SPECIFICATIONS

Model Number	R7246A-SG
Voltage	220-240V~,50Hz
Power	1050W
Rotation Speed ○	600-2300 min ⁻¹
Round Sanding Pad. ∅	215mm
Protection class	II □

SAFETY

GENERAL SAFETY INSTRUCTIONS



WARNING! Read all safety warnings and all instructions. Failure to follow the warnings and instructions may result in electric shock, fire and/or serious injury. Save all warnings and instructions for future reference. The term “power tool” in the warnings refers to your mainsoperated (corded) power tool or battery-operated (cordless) power tool.

1.WORK AREA SAFETY

- > Keep work area clean and well lit. Cluttered or dark areas invite accidents.
- > Do not operate power tools in explosive atmospheres, such as in the presence of flammable liquids, gases or dust. Power tools create sparks which may ignite the dust or fumes.
- > Keep children and bystanders away while operating a power tool. Distractions can cause you to lose control.

2.ELECTRICAL SAFETY

- > Power tool plugs must match the outlet. Never modify the plug in any way. Do not use any adapter plugs with earthed (grounded) power tools. Unmodified plugs and matching outlets will reduce risk of electric shock.
- > Avoid body contact with earthed or grounded surfaces such as pipes, radiators, ranges and refrigerators. There is an increased risk of electric shock if your body is earthed or grounded.
- > Do not expose power tools to rain or wet conditions. Water entering a power tool will increase the risk of electric shock.
- > Do not abuse the cord. Never use the cord for carrying, pulling or unplugging the power tool. Keep cord away from heat, oil, sharp edges or moving parts. Damaged or entangled cords increase the risk of electric shock.
- > When operating a power tool outdoors, use an extension cord suitable for outdoor use. Use of a cord suitable for outdoor use reduces the risk of electric shock.

- > If operating a power tool in a damp location is unavoidable, use an earth leakage circuit breaker. Use of an earth leakage circuit breaker reduces the risk of electric shock.

3. PERSONAL SAFETY

- > Stay alert, watch what you are doing and use common sense when operating a power tool. Do not use a power tool while you are tired or under the influence of drugs, alcohol or medication. A moment of inattention while operating power tools may result in serious personal injury.
- > Use personal protective equipment. Always wear eye protection. Protective equipment such as dust mask, non-skid safety shoes, hard hat, or hearing protection used for appropriate conditions will reduce personal injuries.
- > Prevent unintentional starting. Ensure the switch is in the off-position before connecting to power source and/or battery pack, picking up or carrying the tool. Carrying power tools with your finger on the switch or energising power tools that have the switch on invites accidents.
- > Remove any adjusting key or wrench before turning the power tool on. A wrench or a key left attached to a rotating part of the power tool may result in personal injury.
- > Do not overreach. Keep proper footing and balance at all times. This enables better control of the power tool in unexpected situations.
- > Dress properly. Do not wear loose clothing or jewelry. Keep your hair, clothing and gloves away from moving parts. Loose clothes, jewelry or long hair can be caught in moving parts.
- > If devices are provided for the connection of dust extraction and collection facilities, ensure these are connected and properly used. Use of dust collection can reduce dust-related hazards.

4. POWER TOOL USE AND CARE

- > Do not force the power tool. Use the correct power tool for your application. The correct power tool will do the job better and safer at the rate for which it was designed.
- > Do not use the power tool if the switch does not turn it on and off. Any power tool that cannot be controlled with the switch is dangerous and must be repaired.
- > Disconnect the plug from the power source and/or the battery pack from the power tool before making any adjustments, changing accessories, or storing power tools. Such preventive safety measures reduce the risk of starting the power tool accidentally.
- > Store idle power tools out of the reach of children and do not allow persons unfamiliar with the power tool or these instructions to operate the power tool. Power tools are dangerous in the hands of untrained users.

- > Maintain power tools. Check for misalignment or binding of moving parts, breakage of parts and any other condition that may affect the power tool's operation. If damaged, have the power tool repaired before use. Many accidents are caused by poorly maintained power tools.
- > Keep cutting tools sharp and clean. Properly maintained cutting tools with sharp cutting edges are less likely to bind and are easier to control.
- > Use the power tool, accessories and tool bits etc., in accordance with these instructions, taking into account the working conditions and the work to be performed. Use of the power tool for operations different from those intended could result in a hazardous situation.

5.SERVICE

- > Have your power tool serviced by a qualified repair person using only identical replacement parts. This will ensure that the safety of the power tool is maintained.

SAFETY INSTRUCTIONS FOR POLISHERS

1) SAFETY INSTRUCTIONS FOR ALL OPERATIONS

- a) This power tool is intended to function as a polisher. Read all safety warnings, instructions, illustrations and specifications provided with this power tool. Failure to follow all instructions listed below may result in electric shock, fire and/or serious injury.
- b) This power tool is not recommended for grinding, sanding, wire brushing or cutting off operations. Operations for which the power tool was not designed may create a hazard and cause personal injury.
- c) Do not use accessories which are not specifically designed and recommended by the tool manufacturer. Just because the accessory can be attached to your power tool, it does not assure safe operation.
- d) The rated speed of the accessory must be at least equal to the maximum speed marked on the power tool. Accessories running faster than their rated speed can fly apart.
- e) The outside diameter and the thickness of your accessory must be within the capacity rating of your power tool. Incorrectly sized accessories cannot be adequately guarded or controlled.
- f) The arbour size of wheels, flanges, backing pads or any other accessory must properly fit the spindle of the power tool. Accessories with arbour holes that do not match the mounting hardware of the power tool will run out of balance, vibrate excessively and may cause loss of control.
- g) Do not use a damaged accessory. Before each use inspect the accessory such as abrasive wheels for chips and cracks, backing pads for cracks, tear or excess wear, wire brushes for loose or cracked wires. If the power tool or accessory is dropped, inspect for damage or install an undamaged accessory. After inspecting and installing an accessory, position yourself and bystanders away from the plane of the rotating accessory and run the power tool at maximum no load speed for one minute. Damaged accessories will normally break apart during this test time.

- h) Wear personal protective equipment .Depending on application, use face shield, safety goggles or safety glasses. As appropriate, wear dust mask, hearing protectors, gloves and shop apron capable of stopping small abrasive or workpiece fragments. The eye protection must be capable of stopping flying debris generated by various operations. The dust mask or respirator must be capable of filtrating particles generated by your operation. Prolonged exposure to high intensity noise may cause hearing loss.
- i) Keep bystanders a safe distance away from work area. Anyone entering the work area must wear personal protective equipment. Fragments of the workpiece or of a broken accessory may fly away and cause injury beyond the immediate area of operation.
- j) Hold power tool by insulated gripping surfaces only, when performing an operation where the cutting accessory may contact hidden wiring or its own cord. A cutting accessory contacting a "live" wire may make exposed metal parts of the power tool "live" and could give the operator an electric shock.
- k) Position the cord clear of the spinning accessory. If you lose control, the cord may be cut or snagged and your hand or arm may be pulled into the spinning accessory.
- l) Never lay the power tool down until the accessory has come to a complete stop. The spinning accessory may grab the surface and pull the power tool out of your control.
- m) Do not run the power tool while carrying it at your side. Accidental contact with the spinning accessory could snag your clothing, pulling the accessory into your body.
- n) Regularly clean the power tool's air vents. The motor's fan will draw the dust inside the housing and excessive accumulation of powdered metal may cause electrical hazards.
- o) Do not operate the power tool near flammable materials. Sparks could ignite these materials.
- p) Do not use accessories that require liquid coolants. Using water or other liquid coolants may result in electrocution or shock.

2) KICKBACK AND RELATED WARNINGS

- Kickback is a sudden reaction to a pinched or snagged rotating wheel, backing pad, brush or any other accessory.Pinching or snagging causes rapid stalling of the rotating accessory which in turn causes the uncontrolled power tool to be forced in the direction opposite of the accessory's rotation at the point of the binding.

- For example, if an abrasive wheel is snagged or pinched by the workpiece, the edge of the wheel that is entering into the pinch point can dig into the surface of the material causing the wheel to climb out or kick out. The wheel may either jump toward or away from the operator, depending on the direction of the wheel's movement at the point of pinching. Abrasive wheels may also break under these conditions.
 - Kickback is the result of power tool misuse and/or incorrect operating procedures or conditions and can be avoided by taking proper precautions as given below.
- a) Maintain a firm grip on the power tool and position your body and arm to allow you to resist kickback forces. Always use auxiliary handle, if provided, for maximum control over kickback or torque reaction during start-up. The operator can control torque reactions or kickback forces, if proper precautions are taken.
 - b) Never place your hand near the rotating accessory. The accessory may kickback over your hand.
 - c) Do not position your body in the area where power tool will move if kickback occurs. Kickback will propel the tool in the direction opposite to the wheel's movement at the point of snagging.
 - d) Use special care when working corners, sharp edges etc. Avoid bouncing and snagging the accessory. Corners, sharp edges or bouncing have a tendency to snag the rotating accessory and cause loss of control or kickback.
 - e) Do not attach a saw chain woodcarving blade or toothed saw blade. Such blades create frequent kickback and loss of control.

GENERAL

- This tool should not be used by people under the age of 16 years
- This tool is not intended for use by persons (including children) with reduced physical, sensory or mental capabilities, or lack of experience and knowledge, unless they have been given supervision or instruction concerning use of the tool by a person responsible for their safety
- Ensure that children do not play with the tool
- This tool is not suitable for wet sanding
- **Always disconnect plug from power source before making any adjustment or changing any accessory**

BEFORE USE

- Before using the tool for the first time, it is recommended to receive practical information
- Always check that the supply voltage is the same as the voltage indicated on the nameplate of the tool (tools with a rating of 230V or 240V can also be connected to a 220V supply)
- **Use suitable detectors to find hidden utility lines or call the local utility company for assistance**(contact with electric lines can lead to fire or electrical shock; damaging a gas line can result in an explosion; penetrating a water pipe will cause property damage or an electrical shock)
- **Do not work materials containing asbestos** (asbestos is considered carcinogenic)
- Dust from material such as paint containing lead, some wood species, minerals and metal may be harmful (contact with or inhalation of the dust may cause allergic reactions and/or respiratory diseases to the operator or bystanders); **wear a dust mask and work with a dust extraction device when connectable**
- Certain kinds of dust are classified as carcinogenic (such as oak and beech dust) especially in conjunction with additives for wood conditioning; **wear a dust mask and work with a dust extraction device when connectable**
- Follow the dust-related national requirements for the materials you want to work with
- Do not clamp the tool in a vice
- Use completely unrolled and safe extension cords with a capacity of 16 Amps (U.K. 13 Amps)

AFTER USE

- After switching off the tool, never stop the rotation of the accessory by a lateral force applied against it

USE

Shaft②

- Fold the front and back part together (2a).
- Push the folding lock D to the right position and keep the tip adjacent to the handle .(2b)
- Press the folding lock D towards the handle until the end. (2c) Unfold the handle by pushing the folding lock to the inside.

Replace sanding pad③

- Insert the hex wrench R (size 5) into the hexagonal screw bolt on the sanding block

- Hold the sanding pad firmly, and then turn the wrench counter clockwise to dismount the pad.
- Install new sanding pad by tightening the bolt.



Warning: Only install the specified sanding pad on the machine. In order to ensure optimal performance, the machine should be run at slightly lower speed for several minutes to make the grinding pad fit the sealing surface perfectly. During this process, the white foam particles will come out from the sanding head. However, this won't damage the machine.

Attaching and changing sanding disc③

- Place the sanding disc in the center of the sanding pad and press on. The holes in the sanding disc must be in alignment with the extraction holes in the sanding pad.
- For round sanding pad only: conduct a test run to check that the sanding disc is clamped in the centre.

Extension shaft(optional)④

- use the extension shaft (O) according to the intended operation for higher work surface
- loosen the sleeve on the dust extraction outlet (N) of the upper shaft (F).do not remove the sleeve from the outlet.
- align the rear handle (O₁) with the main handle (E) and insert the sleeve (O₃) on the extension shaft (O) into the outlet (N) with a twist motion all the way to the stop.
- adjust the length of the extension shaft (O) if necessary.pay attention to the marking "max 1.65m" on the extension shaft.tighten the sleeve (N) after assembling/adjusting the extension shaft.

Dust suction⑤

- Remove the vacuum hose with dust bag from the product, if necessary.
- Hold the dust bag over a suitable rubbish bag.
- Pull the clasp off the dust bag and empty it into the rubbish bag.
- Slide the clasp onto the rails on the dust bag and re-attach the vacuum hose and dust bag to the product.

Tool standard/airflow control⑧

- Tool handle P1 prevents the hose from damage when putting the tool aside during work breaks
- Control the airflow by sliding suction power adjustment ring P3 over the opening in tool connector P2
- The vacuuming power is at its lowest level when the opening is fully visible

Switching the machine on and off

- Turn on/off the drywall sander by switch G Electronic speed control
- Adjust the speed by turning the speed wheel M, user can choose different speed for different sanding surface.
- Constant speed control Keep the machine running at the same speed as selected. Do not overload by excessive pressure.

SANDING OPERATIONS

Once the machine and vacuum cleaner are set up and all safety measures and equipment are in place, begin by turning on the vacuum cleaner and then the machine. (If you are using a vacuum cleaner with integrated switching, then simply turn the machine on.)

Round sanding head⑥

- Begin sanding and carefully contact the work surface as lightly as possible-just enough to keep the sanding head flat against the surface.
- The pivot point in the sanding head allow the sanding disc to follow the contours of the work surface.

Sanding Ceiling⑪

- Put the rubber band into the pothook to fix the head (Fig.11), keep the sanding pad and handle vertical, keep the sanding pad and ceiling in same level, then we can use to sand the ceiling.

- The best technique is to use overlapping sweeps and keep the head in constant motion. Never stop too long in any one place or there will be swirl marks. With experience it will be very easy to create excellent results.



Ensure that the sanding disc you are using is suited to the task, Overly coarse grit paper may remove material too quickly to control. While overly fine grit paper may clog too often and not shape down the surface.



Take care to avoid sharp projections and nails, etc. This will wipe out the sandpaper and probably damage the sponge pad as well.

MAINTENANCE / SERVICE

- Store the tool in its protective case in a dry and locked up place, out of reach of children
- Always keep tool and cord clean (especially ventilation slots)



do not attempt to clean ventilation slots by inserting pointed objects through openings



disconnect the plug before cleaning

ENVIRONMENT

Do not dispose of electric tools, accessories and packaging together with household waste material (only for EU countries)

- in observance of European Directive on waste of electric and electronic equipment and its implementation in accordance with national law, electric tools that have reached the end of their life must be collected separately and returned to an environmentally compatible recycling facility

Symbols

On the product, the rating label and within these instructions you will find among others the following symbols and abbreviations. Familiarize yourself with them to reduce hazards like personal injuries and damage to property.

V~	Volt, (alternating voltage)	mm	Millimetre
Hz	Hertz	kg	Kilogram
W	Watt	dB(A)	Decibel (A-rated)
/min or min ⁻¹	Per minute	m/s ²	Metres per seconds squared



Lock / to tighten or secure.



Unlock / to loosen.



Note / Remark.



Caution / Warning.



Read the instruction manual.



Wear hearing protection.



Wear eye protection.



Wear a dust mask.



Wear protective gloves.



Wear protective, slip-resistant footwear.



Switch the product off and disconnect it from the power supply before assembly, cleaning, adjustments, maintenance, storage and transportation.



This product is of protection class II. That means it is equipped with enhanced or double insulation.



The product complies with the applicable European directives and an evaluation method of conformity for these directives was done.



WEEE symbol. Waste electrical products should not be disposed of with household waste. Please recycle where facilities exist. Check with your Local Authority or local store for recycling advice.